



Key Words	Definitions
abbey	The building or buildings occupied by a community of monks or nuns.
beach	A strip of land covered with sand, pebbles, or small stones at the edge of a body of water, especially by the sea.
city	A human settlement of notable size.
coastline	The land along a coast.
continent	A continuous expanse of land, there are 7 in total.
country	A nation with its own government occupying a particular territory.
county	A division of some countries into smaller areas.
key	A guide that explains what the symbols on a map mean.
map	A representation of an area of land or sea showing physical features.
sea	The expanse of salt water that covers most of the earth's surface and surrounds its landmasses.
symbol	Images to represent real world features on a map.

Where is Whitby and what is it famous for?
 Whitby is on the East Coast, in North Yorkshire. It is a seaside town famous for its abbey, it has a fishing port and Captain Cook learned seamanship here. Whitby jet was mined here by the Romans and Victorians, Whitby is associated with the novel and character Dracula.

Maps







Europe



Yorkshire



Whitby

Important figures			
Explorers			
Captain James Cook	Marie Tharp	Dracula	Vlad the Impaler
<p>Captain James Cook was a British explorer, navigator, cartographer, and captain in the British Royal Navy, famous for his three voyages between 1768 and 1779 in the Pacific Ocean and to Australia.</p> 	<p>Marie Tharp was an American geologist and oceanographic cartographer. In the 1950's she helped to produce the first scientific map of the Atlantic Ocean floor.</p> 	<p>Dracula is a fictional vampire, created by Bram Stoker, who lives in Whitby. He is believed to live in the ruins of the Abbey.</p> 	<p>Vlad the Impaler lived in Transylvania in the 15th Century. He was known for his cruel methods of punishing his enemies and is believed to be who Bram Stoker based his character Dracula on.</p> 

Monday	Tuesday	Wednesday	Thursday	Friday
HWK – Maths Book	HWK – Reading	HWK – Grammar Book	HWK – Reading	HWK – Spellings

Key Dates:

- Community Woodland Sessions – Friday 6th September
- Whitby Trip – Thursday 19th September

KEY VOCABULARY

electricity

electricity is a **form of energy**; we can control it and use it

electrical current

the **flow of electricity**

electric shock

when **electricity flows through the human body causing a shock**; exposure to electrical energy can be dangerous, resulting in damage or death

circuit

a **path** which electricity flows around

battery

a **store of energy**, also known as a cell

light bulb

a component that **converts electrical energy to light energy**

switch

a component that **can make or break an electrical circuit**

wire

a **thin piece of metal covered in plastic** that conducts electricity

conductor

materials that **allow electricity to pass through** them are called conductors

insulator

materials that **do not allow electricity to pass through** are called insulators

battery



bulb



wire



switch



electrical symbols

series circuit

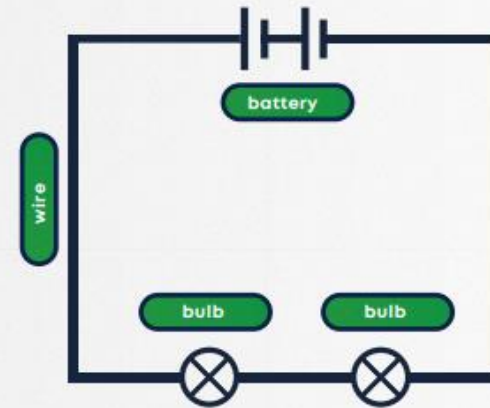

a series circuit has one path for electricity to flow

AA battery

1.5 V (volts)



car battery

12 V (volts)



Granville T Woods (1856-1910)

an inventor and electrical engineer who worked on many inventions that made electrical railways safer and more efficient

